

XOMAX

Instruction Manual

MODEL: XM-D749



MODEL: XM-D750



1-Din Digital Multimedia Player
7" Motorized TFT Touch Screen
AM/FM Receiver, USB, Bluetooth

IMPORTANT:

- Do not operate this digital video player while the vehicle is moving.
- This is a safety feature to prevent driver distraction.
- It's illegal in most country for the driver to view video while the vehicle is moving.
- The digital video functions will be only operated when vehicle is in park and the parking brake is engaged.

To establish a safe level:

- Start your volume control at a low setting.
- Slowly increase the sound until you can hear it comfortably and clearly, and without distortion, we want you listening for a lifetime.
- Once you have established a comfortable sound level, set the dial and leave it there.

How to Handle Discs:

- Handle a disc by its edges. Do not touch the playing side.
- Before inserting a disc, wipe the disc outward from the disc center with a clean, soft, dry and lint-free cloth. Do not use solvents or thinners such a petrol/benzene or cleaners.
- After removing a disc from the disc slot, place the disc in a sleeve or case to keep it clean and prevent scratches.
- Do not stick paper or tape on the disc surface. If there is glue(or adhesive) on the disc surface, remove it before using the disc.



Precautions:

1. To reduce the risk of fire, electric shock, and interference, do not attempt to repair this product yourself. Refer all servicing to a qualified technician.
2. This digital video player is compatible with VIDEO/AUDIO discs with 12 cm size:

- DVD disc
- VCD disc
- CD, CD-R, CD-RW disc
- MP3 disc

3. Do not switch on this digital video player for long time when the vehicle's motor is switched off. This could cause the vehicle battery to discharge and the vehicle can no longer be started.

4. Do not apply strong mechanical stress like drop, shock or any force to the TFT LCD. Do not too hard hit, press or rub the TFT LCD display surface. If the display surface is dirty, please wipe the surface softly with cotton swab or clean cloth.

5. Never place any foreign objects into the openings of this product such as disc slot, USB port, AUX IN jack. Otherwise you might damage the slots and connectors.

6. Do not throw the battery cell of remote control into fire as this may cause an explosion. Keep battery cells out of reach of children.

Copyright Notes:

This product incorporates copyright protection technology that is protected by method claims of certain U.S. patents and other intellectual property rights owned by Macrovision Corporation and other rights owners.

Use of this copyright protection technology must be authorized by Macrovision Corporation, and is intended for home and other limited viewing uses only unless otherwise authorized by Macrovision Corporation. Reverse engineering or disassembly is prohibited.

Region Management information:

This product is designed and manufactured to respond to the Region Management Information that is recorded on a digital video disc. If the Region number described on the digital video disc does not correspond to the Region number of this DVD player, the disc cannot be played on by this DVD player.

INSTALLATION:

- **Before Installation:**
 - We recommend you to let a professional technician install the unit in vehicle.
 - Disconnect negative battery terminal of vehicle.
 - Remove the trim ring from unit (if installed).

 - **Mounting the Head Unit:**
 - Carefully remove the existing head unit.
 - Before finally installing this product, connect wiring harness temporarily and make sure it's all connected up properly and test the head unit if it can work properly. (Consult a qualified technician if you are unsure)
 - Insert the mounting sleeve into the installation dashboard.
 - Bend multiple mounting tabs around the mounting sleeve until the mounting sleeve is secure.
 - Connect all wiring harnesses and slide the head unit into the mounting sleeve until it clicks into place.
 - To fix this DVD player onto the rear part of the chassis using the mounting sleeve, metal strap, hex bolt and screws to the vehicle.
- Note: if you need other screws to fix other terminal, please buy from your dealer according to the drilling of holes size.*

INSTALLATION:

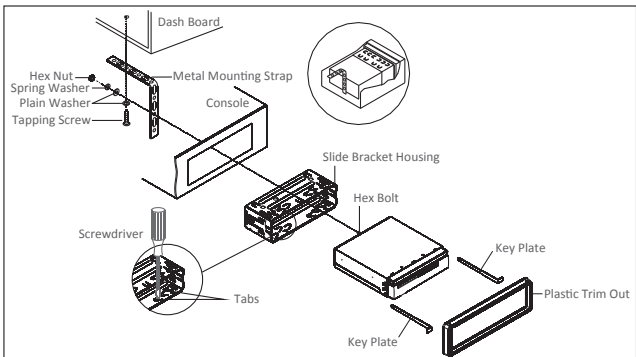

Wiring Connections:

ANT

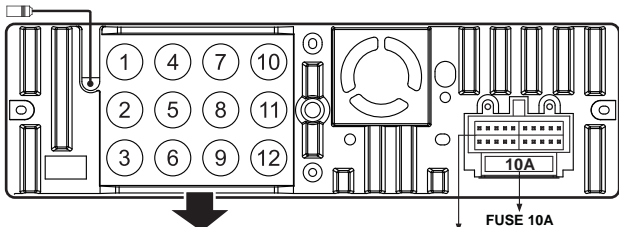

Audio/Audio I/O Connections

1. Rear View Video input (Yellow)
2. Subwoofer Output 2 (Green)
3. Subwoofer Output 1 (Green)
4. Video input (Yellow)
5. Left Audio input (White)
6. Right Audio input (Red)
7. Video Output 1 (Yellow)
8. Rear Left RCA Output (White)
9. Rear Right RCA Output (Red)
10. Video Output 2 (Yellow)
11. Front Left RCA Output (White)
12. Front Right RCA Output (Red)

Speaker/Power Connections

- Gray: Front Right (+)
- Gray/Black: Front Right (-)
- White: Front Left (+)
- White/Black: Front Left (-)
- Violet: Rear Right (+)
- Violet/Black: Rear Right (-)
- Green: Rear Left (+)
- Green/Black: Rear Left (-)
- Red: ACC 12V (+)
- Yellow: BATTERY 12V (+)
- Black: GND (-)
- Blue: ANT (+)
- Orange: BACK (+)
- Pink: BRAKE (-)
- Orange/Black: ILL (+)
- Brown: SWC 1
- Brown/white: SWC 2
- Black: SWC-GND

Wiring Connections:

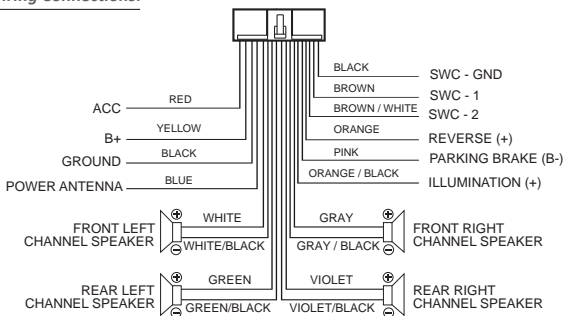

Note: the ground connection cable (parking brake B-) must be connected in order for pictures to be played back to the monitor. If the cable has not been correctly connected, warning message appears on the monitor.



Control Panel Buttons:



1. OPEN/ BUTTON

Briefly press to slide the monitor out of slot.
Repeatedly press this button to tilt up and down the monitor.
Press and hold this button to slide the monitor inside of the slot.

2. /MODE BUTTON

In power off mode, press it to turn on the unit. Long press it to turn off the unit.
In power on mode, short press it repeatedly to select one mode of the RADIO, DISC, USB, Bluetooth and AUX IN(AV IN).

3. Volume KNOB / SELECT BUTTON

Rotate the VOL knob to increase or decrease the volume level.
Press the SEL button to access to audio settings: Volume, Dimmer, Bass, Treble, Balance, Fader, Loudness On/off, EQ Standard/Classic/Rock/Pop/Jazz/ Electric /User.

4. Handsfree Microphone

Uses the bluetooth handsfree system to receive your voice when calling.

5. IR REMOTE SENSOR

6. Tune Previous/ Skip Previous track, Reject and End Call ()

In Radio mode, press it to tune radio frequency downward one step at a time.
Press and hold to scan strong signal radio station downward step by step.
In Disc/USB/BT music playback, press this button to skip previous track.
Press and hold this button to fast backward playback.
In BT mode, press this button to reject an income call or end a call.

Control Panel Buttons:

7. MUTE ON/OFF, PTY(Program Types)

*In power on mode, press the MUTE button to toggle mute on or off.
In radio mode, press and hold the PTY button, you can select specific stations of a certain program type such as News, Info, sports, Talk, Rock etc..*

8. ►|| (PLAY/PAUSE) /CH 1-6 (PRESET RADIO STATION)

• In Disc/USB/BT music playback mode

Press this button to pause playback, touch again to resume playback.

In Radio Mode

Press repeatedly to preset radio station. With this system a total of 30 stations can be stored in the memory. Each band store up to six preset stations.

The stations might be FM1, FM2, FM3, AM1 (MW1) and AM2 (MW2) band.

• In Radio Mode

Press repeatedly this button to recall the preset stations which had been stored in the memory in advance.

9. Tune Nest/ Skip Next track, Make a Call, Receive and Redial Last Call (↶)

In Radio mode, press to tune radio frequency upward one step at a time.

Press and hold to scan strong signal radio station upward step by step.

In Disc/USB/BT music playback, press to skip next track.

Press and hold to fast forward playback.

In BT phone mode, press the ↶ button to make a call / receive a call / redial the last dialed phone number.

10. ▲ (EJECT) BUTTON

Insert the disc, label side facing up, until the mechanism senses its presence and draws the disc in. Press it to eject the disc.

11. USB PORT

The USB port is designed for media playback from flash memory devices and charging for iPhone / android mobile phone. The charging current consumption is 1 ampere. Open the cover for USB device use.

If you would like to play MP4/MP3/WMA files contained in a USB stick.

Please open the cover, and insert the USB stick into the USB port.

12. AUXILIARY INPUT JACK

Insert an external device to this 3.5mm auxiliary jack in order to have audio output of the device through the unit.

13. BAND(For XM-D750 Only)

In radio model, press BAND to select between FM1, FM2, FM3, AM1 and AM2 bands.

Control Panel Buttons:

14. TA(Traffic Announcement Settings)/AF(Alternative Frequencies), (For XM-750 Only)

In Radio mode, briefly press the TA/AF button to toggle TA on or off.

- **ON:** TA symbol will be displayed if this function is activated. In the TA mode, once a traffic message is received, the unit switches to the radio station from a different mode(e. g. USB mode).

- **OFF:** The function is deactivated.

In Radio mode, press and hold the TA/AF button to toggle AF on or off, the device searches the best frequency for the selected station.

- **ON:** If a certain broadcast station has bad reception, the device switches automatically to a broadcast station broadcasting the same program via the same RDS broadcast chain.

- **OFF:** The function is deactivated.

15. Release the detachable front panel

If you want to remove the front panel from the chassis for safe keeping, please press this release button to detach this little front panel.

16. RESET SYSTEM

The RESET button is used to reset all parameters to factory default settings. This function may be used when the LCD does not display normally or sound is distorted, or when any of controls are disabled.

Gently press the RESET button to reset your system with a thin object with a pointed end.

Remote controls:

1. OPEN /

Briefly press this button to slide the monitor out of slot. Repeatedly press this button to tilt up and down the monitor.

Press and hold this button to slide the monitor inside of the slot.

2. (Power on/off), MODE

Press it to turn the unit ON or OFF.

Press it briefly to select different modes: DISC, RADIO, USB, Phonelink, Bluetooth and AUX IN / AV IN

3 & 7. /

In Disc/USB Playback mode, press each one to reverse and fast forward with X2, X4, X8, X20 speed.

In Radio mode, press each one to select the next or the previous preset station.

4. AS /

In Radio mode, press and hold AS button to store 18 FM stations and 12 AM stations automatically.

Press it briefly to recall the preset station that stored in memories in each band.

Press the  button to make a call / receive a call / redial the last dialed phone number.

5. (Play/Pause)

In Disc/USB/BT music playback mode, press it to pause playback.

Press it again to start where playback stopped.

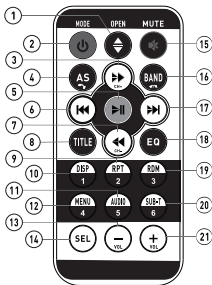

Remote controls:

6 & 17. ⏮ / ⏭

In Disc/USB/BT music playback, press both buttons to skip next or previous track.

In Radio mode, press each one to seek tuning down or up.

Press and hold each one to manual tuning down or up.

8. TITLE

In DVD playback, press this button to enter title menu which is recorded on the media. (If the DVD disc with title menu).

9. RPT(Repeat playback) / 2

In Disc/USB playback mode, press and hold the RPT button to enter different repeatedly playing modes: Repeat title, Repeat One, Repeat Dir(folder), Repeat All.

In radio mode, press to store or recall the preset station 2.

10. DISP / 1

In video playing mode, press and hold DISP button show information such as Title number, Chapter number, Track number, elapsed time, remain time etc.

In radio mode, press to store or recall the preset station 1.

11. AUDIO / 5

In DVD playback, press and hold AUDIO button repeatedly to switch the language of audio if the DVD disc is recorded with multi-languages.

In VCD playback, press and hold AUDIO button repeatedly to switch L/R or stereo audio track.

In radio mode, press to store or recall the preset station 5.

12. MENU / 4

In DVD playback mode, press and hold the MENU button to display the root level directory of DVD disc.

In radio mode, press to store or recall the preset station 4.

13 & 21. VOL+/VOL-

Use these controls to adjust the volume level.

14. SEL

Press to turn to EQ settings.

15. MUTE

In power on mode, press the MUTE button to toggle mute on or off.

16. BAND /

Press BAND to select between FM1, FM2, FM3, AM1 and AM2 bands.

In BT mode, press the  button to reject an income call or end a call.

18. EQ

Press repeatedly to cycle through the different equalizer curve presets you may wish to use for enhanced listening.

19. RDM / 3

In Disc/USB Playback mode, press and hold RDM button to play tracks in random order, press again to cancel the RDM function.

In radio mode, press to store or recall the preset station 3.

20. SUB-T/6

In DVD playback, press and hold the SUB-T button repeatedly to switch the language of subtitle if the DVD disc is recorded with multi-subtitles.

In radio mode, press to store or recall the preset station 6.

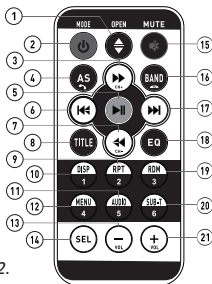

Setup Operations:

Main Menu:

In each mode, touch the  icon to enter the main menu as below image. In the main menu, tap the desired icon to enter each of the following settings: Disc(CD/VCD/DVD), Radio, Phonelink, USB, Bluetooth, EQ Preset, AUX/AV IN, F.CAM(Front View Camera), Setup.

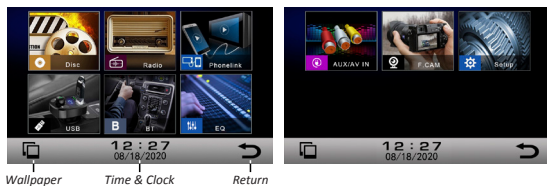



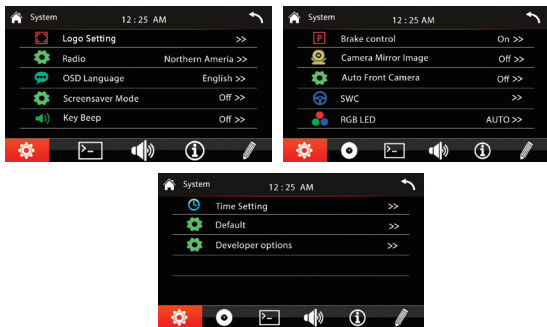

In main menu, touch the “Setup” icon to enter the setup menu, as below image. Then user can set up or adjust the general settings for this DVD player.



A. System: Logo Setting, Radio Area, OSD Language, Screensaver Mode, Key Beep, Parke contro, Headlight Detection, Camera Mirror Image, Auto Front Camera On/Off, SWC, RGB LED Setting, Time Setting, Default.

- Radio Area: To choose the radio area: EUROPE, Northern America, South America, Russia, Japan, Asia.
- OSD Language: English, Chinese, Arabic, Greek, Thai, Hebrew, Turkish, Russian, French, German, Spanish, Persian, Indonesian, Portuguese, Italian.
- Screensaver Mode: Enables or Disables the screensaver of this DVD player.
- Key Beep: Enables or Disables the beep buzzer signal to confirm use.

Setup Operations:

- **Parke control:** Enables or Disables the brake detection.
This safety feature to prevent driver distraction. We recommend user to enable this brake detection function. When enable this function, user were forbidden to watch video from this unit while this system is not detect the brake signal of the parking brake.
- **Camera Mirror Image:** Enables or Disables the camera mirror image.
- **Auto Front Camera:** Allows you to preset the duration of the front view camera video: Off, 5 seconds, 10 seconds, 15 seconds.
- **SWC(Steering Wheel Control)**
Tap "SWC" to enter the study operation menu.
First, make sure the SWC connecting wires have been connected to this unit.
Before study, tap the  icon to clear all previous settings.
Press and hold a steering wheel button, at the same time, tap the function button on touch screen that you want to set on to the steering wheel.
- **RGB LED (Key Lights):**
- To preset the color of button illumination: Red, Blue, Purple, Green, Yellow, Cyan, White, Auto(color automatically change one by one), LED Off.
- **Time Setting:**
Tap the "Time Setting" to enter the time setting interface, tap the  and  button to adjust Year, Month, Day, Hour, Minute.
Tap the  button to preset 12 or 24 Hours format as sytem clock time format.
Tap the  button to preset date format.
- **Default**
Tap this item to restore to all parameters to factory default settings.

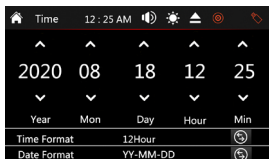
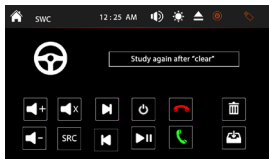

B. DISC(DVD Setup):

Tap the  icon to set up the DVD system language:

- **Audio Language:** Chinese, English, Japan, French, Spanish, Portuguese, Latin, German
- **Subtitle Language:** Chinese, English, Japan, French, Spanish, Portuguese, Latin, German
- **Menu Language:** Chinese, English, Japan, French, Spanish, Portuguese, Latin, German
- **Password:** Allows you to change the password, first input old password, then you can change the password for parental control rating as your favour. The factory default password is "0000".
- **Rating:** Every time changing parental control rating, user have to input the password. User can select one of below suitable parental control rating: 1 Kid Safe, 2 G, 3 PG, 4 PG 13, 5 PG-R, 6 R, 7 NC-17, 8 Adult.

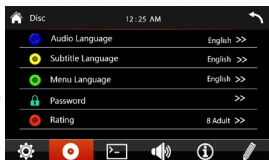

Setup Operations:

C. Screen(Video Settings)

Tap the  icon to set up the video parameter of screen:

- Adjust(Video Parameter Settings)

Tap this item to set the Brightness, Contrast, Hue, Saturation, Sharpness of this TFT screen.

- Brightness: 00, ~, 36
- Contrast: 00, ~, 36
- Hue: 00, ~, 36
- Saturation: 00, ~, 36
- Sharpness: 00, ~, 36

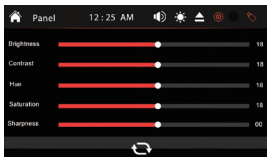

Tap the  icon to clear all previous settings.

- Touch Calibration

Touch this item to enter touch screen calibration mode,

Tap the cursor “+” continuously until it move to next position. Follow the cursor to finish the calibration of touch screen.

- Wallpaper: To change the wallpaper.

D. Audio Settings

Tap the  icon to enter the audio setting:

Tap the “car” icon to enter the sound effect mode, tap the EQ button to enter EQ setting.

- Sound effect:

Tap the FL, FR, RL, RR, ALL button to preset the sound effect in car.

Move the blue circle at the middle of “car inside” interface to quick preset sound effect for driver, front seat passenger, left back passenger, right back passenger and all passengers in the car.

- Tap the “↺” button to clear all the audio settings.

- Tap the “↻” button to exit from the audio setting.

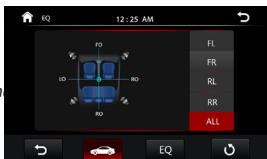

- EQ Presets:

- User can preset EQ: User -> POP -> Classic -> Rock -> Jazz.

- Tap LOUD button to enables or disables loudness.

- Tap SUB button to enables or disables subwoofer output.



E. Version (System information)

Tap this item to view the software version.

F. Version (Factory Setup)

Tap this item to enter factory setup.

Radio Operations:

Press the **MODE** button on the remote control, or tap the “Radio” icon on touch screen to enter radio mode.

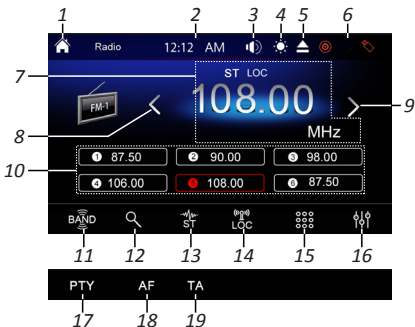

1. Home Page
2. Clock Time
3. Volume Level Adjust
4. TFT Screen Backlight brightness Adjust
5. Disc Eject
6. Active Media
7. Current Radio Reception State
- 8/9. Tune/Seek Down & Tune/Seek Up
Tap this button to seek tuning down or up.
Tap and hold this button to move radio frequency down or up one step at a time.
10. Preset Stations
Tap and hold one of preset station touch buttons to store the preset station.
Tap one of preset station touch buttons to recall the preset station.
11. Band Selector
12. (Automatic Store Preset Stations, Automatic Scan Preset station)
Tap and hold this button for more than 2 second to store station automatically.
Tap this button to recall each preset station that stored in the memories.
13. Stereo/Mono Reception
14. DX/LOC Reception
15. Input a specific radio frequency
16. Audio Setting
17. PTY(Program Types)
Touch to display program types. Search for stations according to program type.
18. TA(Traffic Announcement)
Tap the TA button to enables or disables the TA function (traffic information).
This function is used for maintaining a program being listened to during a trip if its frequency changes.
19. AF(Alternative Frequencies)
Tap this button to enables or disables the alternative frequency seek mode (AF).
When this function is enabled, the tuner will periodically scan received frequencies and play any traffic information message that may be broadcast.

DVD/CD/MP3/USB Card Operations:

Insert DVD/CD Disc

With the label facing up, insert a standard size DVD/CD disc into the disc slot. Playback will begin automatically.

Eject DVD/CD Disc

To eject a disc, first press the ►|| button to stop playback, then press the ▲ button on faceplate) or tap the  icon on the touch screen to eject the disc.

USB Connection

- This USB port is designed for media playback from flash memory devices. If you would like to play MP4/MP3/WMA/JPEG files contained in a USB flash memory device, please insert the USB flash memory into the USB port. The unit will play automatically MP3/MP4/JPEG files.
- This USB port is also designed for phonenumber and charging for iPhone / android mobile phone. The charging current consumption is 1 ampere.

- DVD Playback

Insert a video disc in the disc slot for video disc playback. Press MODE button on the remote control, or tap the "DISC" icon on touch screen to switch DVD playback.



- | | |
|---|-----------------------------------|
| 1. Home Page | 11. Root Menu |
| 2. Clock Time | 12. Next Page of the Menu Bar |
| 3. Volume Level Adjust | 13. Previous Page of the Menu Bar |
| 4. TFT Screen Backlight brightness Adjust | 14. Repeat Playback |
| 5. Disc Eject | 15. Random Playback |
| 6. Active Media | 16. Title Menu |
| 7. Previous Track / Fast backward | 17. Zoom In/ Zoom Out |
| 8. Play/Pause | 18. Multi-Subtitle Language |
| 9. Next Track / Fast forward | 19. Multi-Angle View |
| 10. Stop Playback | 20. Audio Settings |
| | 21. Multi-Audio Language |

DVD/CD/MP3/USB Card Operations:

- VCD Playback:

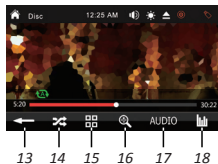

1. Home Page
2. Clock Time
3. Volume Level Adjust
4. TFT Screen Backlight brightness Adjust
5. Disc Eject
6. Active Media
7. Previous Track / Fast backward
8. Play/Pause
9. Next Track / Fast forward
10. Stop Playback
11. Repeat Playback
12. Next Page of the Menu Bar
13. Previous Page of the Menu Bar
14. Random Playback
15. PBC(Playback Control) On/Off
16. Zoom In/ Zoom Out
17. Audio Track Selector
18. Audio Settings

- CD, CD-R/CD-RW/ MP3 Disc Playback:

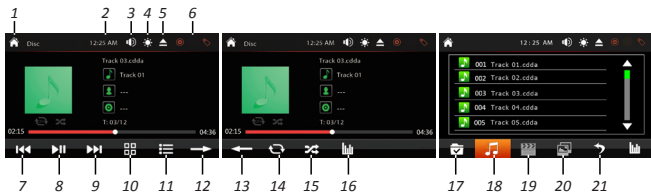

1. Home Page
2. Clock Time
3. Volume Level Adjust
4. TFT Screen Backlight Brightness Adjust
5. Disc Eject
6. Active Media
7. Previous Track / Fast backward
8. Play/Pause
9. Next Track / Fast forward
10. Sort the List of the Folders and Files
11. View the Music File List
12. Next Page of the Menu Bar
13. Previous Page of the Menu Bar
14. Repeat Playback
15. Random Playback
16. Audio Settings
17. View the Root Directory in Disc
18. View the Music Files/Folders
19. View the Video Files/Folders
20. View the Photo Files/Folders
21. Return

DVD/CD/MP3/USB Card Operations:

- MP3 Disc/USB Card Playback:

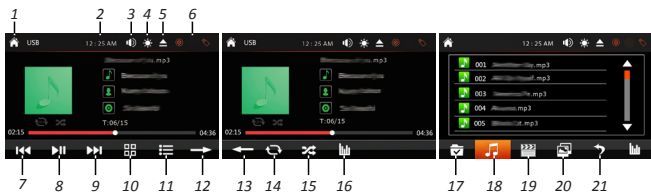

1. Home Page
2. Clock Time
3. Volume Level Adjust
4. TFT Screen Backlight Brightness Adjust
5. Disc Eject
6. Active Media
7. Previous Track / Fast backward
8. Play/Pause
9. Next Track / Fast forward
10. Sort the List of the Folders and Files
11. View the Music File List
12. Next Page of the Menu Bar
13. Previous Page of the Menu Bar
14. Repeat Playback
15. Random Playback
16. Audio Settings
17. View the Root Directory in USB Flash Memory Device
18. View the Music Files/Folders
19. View the Video Files/Folders
20. View the Photo Files/Folders
21. Return

- Photo Playback:



1. Home Page
2. Clock Time
3. Volume Level Adjust
4. TFT Screen Backlight Brightness Adjust
5. Disc Eject
6. Active Media
7. Previous Photo
8. Play/Pause
9. Next Photo
10. Sort the List of the Folders and Files
11. View the Photo File List
12. Next Page of the Menu Bar
13. Previous Page of the Menu Bar
14. Repeat Playback
15. Zoom In/ Zoom Out
16. Rotate Photo
17. Audio Settings

Bluetooth Operations:

-Pairing and Connecting



Before using a Bluetooth phone with this unit, the phone must be paired and connected. The Bluetooth signal of the unit will broadcast when the power is on. This DVD player will displayed as "XOMAX" on your phone.

When prompted, enter the pass code "0000" on your phone. Once paired, the Bluetooth phone should automatically connect this unit whenever the unit is in range.

- Make a call

Input the phone number by using the keypad in Bluetooth mode.

- Making and Ending a Call

Tap  to make a call, and tap  to end a call.

- Redial last dialed number.

Tap  to redial the last dialed phone number.

- Transferring Audio

Tap  icon to transfer audio between this car bluetooth hands-free system and mobile phone.

- Disconnect or reestablish bluetooth connection

Tap  to disconnect the bluetooth connection.

Tap  to reconnect the bluetooth connection.

- Viewing Recent Call List

Tap  icon to view the income calls.

Tap  icon to view the outgoing calls.

Tap  icon to view the missed calls.

Tap  icon to refresh the recent call list.

- Contacts List (Phonebook)

Tap  icon to view the contacts(phonebook).

Tap  icon to refresh the phone book.

Tap  icon to and input a key-letter to retrieve the specified contacts.

- Streaming Audio

Tap  icon on bluetooth mode to enter the music control playback interface.

Tap  icon to skip to the previous track.

Tap  icon to play or pause the music.

Tap  icon to advance to the next track.

- Setup

Tap  icon to set auto connect, auto answer and Pin Code.

- Audio Settings

Tap  icon to set sound effect and EQ settings.

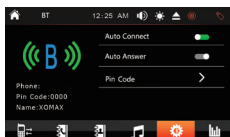
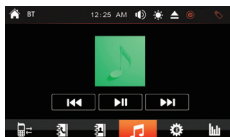
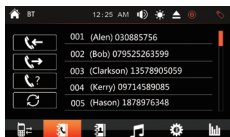
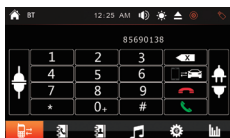

Android Phone Link Operations:

Phone link allows you to mirror the screen of certain Android smartphones on the screen of this car DVD player. Simply connect your device to the USB port and you're ready to see your favorite smartphone apps directly on the screen.

- Android phone link:

1) Please scan one of QR code on right side to download the "Phonelink" app and install it to your smartphone.



AMAZON GOOGLE

2) Connect the original cable of your Smartphone, first to the car DVD player in the USB port, and then connect it to your phone.

3) Now the car DVD player's screen will do the mirror function with your smartphone and you will be able to run any application or function of your smartphone.

Using of the Icons:

1. ↶ : Return to the previous step
2. 🏠 : Return to home page of smart devices
3. 🖥️ : Landscape mode (Rotate the screen)
4. 🚪 : Exit the phone link mode

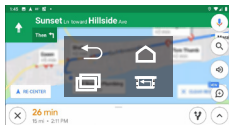

Note:

- a. To unlink your smartphone from the car DVD player, just disconnect the USB cable again.
- b. For Android smart devices, this unit support two-way control (both by the car DVD player and connected smart devices).
- c. For Android smart devices, the Bluetooth must be connected, to have sound output.
- d. Some phones do not support Landscape mode on the home screen.

Technical Specifications:

- 1 DIN Size Universal Standard
- Power Output: 4 x 60 Watt (240 Max.)
- 7 inch Wide Screen TFT Video Display
- Pixel Resolution: 800 x 480 Pixels
- Brightness: 400 Nits
- Aspect Ratio 16:9 High Definition
- Video System: NTSC/PAL (Auto Recognition)
- FM Tuner Frequency Range: 87.5 ~ 108.0 KHz (50KHz/Step)
- AM(MW) Tuner Frequency Range: 522 ~ 1620 KHz (9KHz/Step)
- Bluetooth A2DP, AVRCP Support
- Loudly Speaker Impedance: 4 Ohm
- Signal to Noise Ratio: 60dBA
- Frequency Response: 20Hz - 20KHz
- Connection Interface: AV (RCA) Inputs/Outputs,Subwoofer Output
- Multimedia Disc Support: DVD/VCD/CD/CD-R/CD-RW/VCD/MP3/MPEG
- File Compatibility: JPEG, MP3, AVI, WAV and More
- USB Flash Memory Device
- Working Voltage: DC 12V
- Chassis Dimensions (W x H X D): 178 x 50x 166 mm (Not Included Metal Sleeve)

Made for STEL Multimedia GmbH,
Paewesiner Weg 20, 13581 Berlin,
GERMANY



E-mark certification

The possible alterations of the technical data, which are related to further model modification, are valid and reserved without any preadvices.